

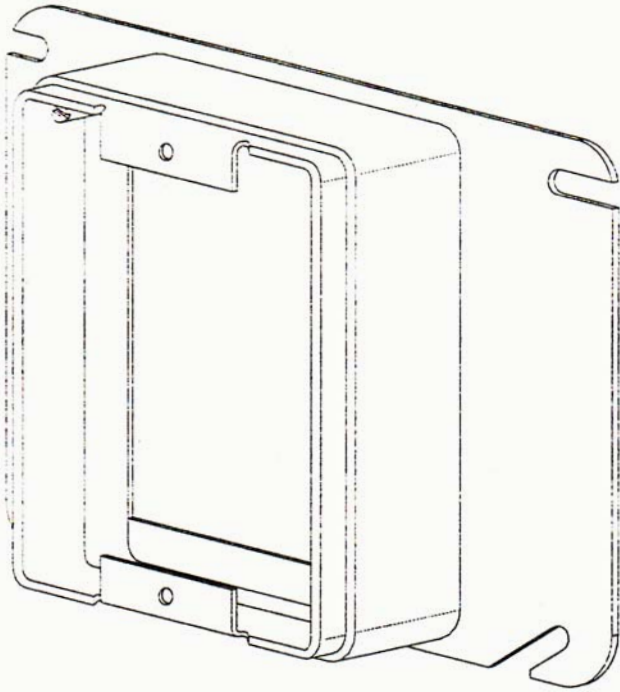

ACS/Uni-Fab Power Products

ADJUSTABLE 1 GANG MUD RING



FEATURES:

Allows the device to be leveled with the finish wall during trim-out.

Reduces the need for multiple ring depths for wall thickness.

Expandable from 5/8" to 1".

For one gang applications, utilizing 4" Square box.

Made from durable .062" thick galvanized steel.

APPLICATION:

Adjustable mud ring is to be used in finish wall (i.e. Sheetrock, tile, etc..) applications to mount single gang devices.



www.Lawlessales.com

5359 N. 118th Court / Milwaukee, WI 53225

TEL: 414.393.1400 or 800.962.9666 / FAX:414.393.1430











ACS/Uni-Fab

ACS/Uni-Fab

Branch Circuit Power Systems

Device Protection

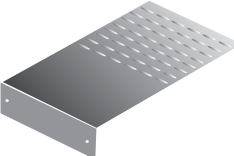
<u>Description</u>	<u>Part No.</u>
 Duplex Protector	P-D
 Duplex Angle Protector	P-DA
 Block Device Protector	P-B
 Block Device Angle Protector	P-BA
 Switch Protector	P-S
 Switch Angle Protector	P-SA
 Blank Protector (1 Gang)	P-1
 Blank Protector (2 Gang)	P-2
 S-Bracket	
 Far-side-stand-off	FSSO